

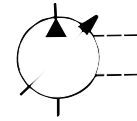

**PUMP, VARIABLE DELIVERY
PVWJ
011, 014 & 022**

ENGINEERING

1



P-C & P-K Controls

Installation

Pressure Compensator w/Soft Start Control (A Frame)

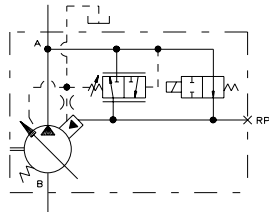

PUMP WITH P-C (N.O.) CONTROL

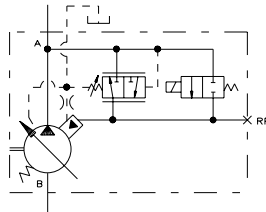

PUMP WITH P-K (N.C.) CONTROL

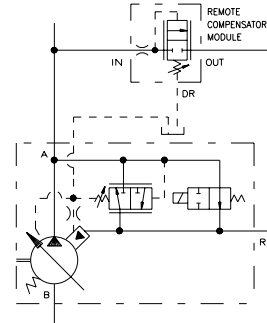

PUMP WITH REMOTE PRESSURE CONTROL

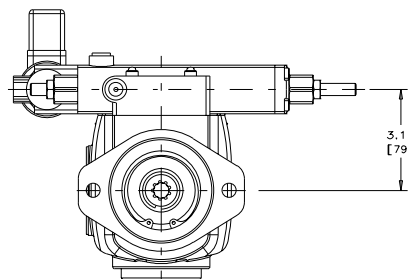
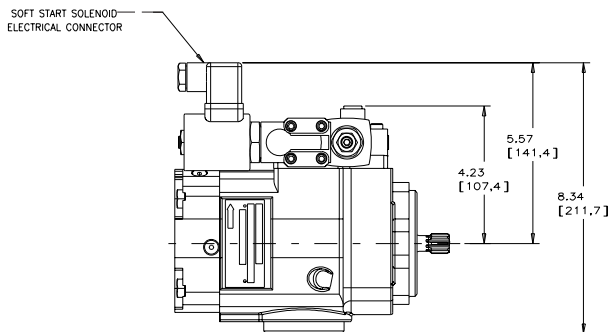
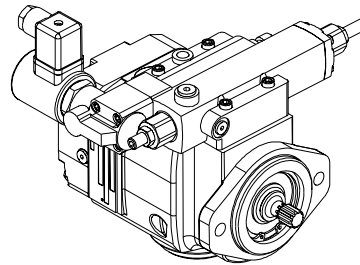
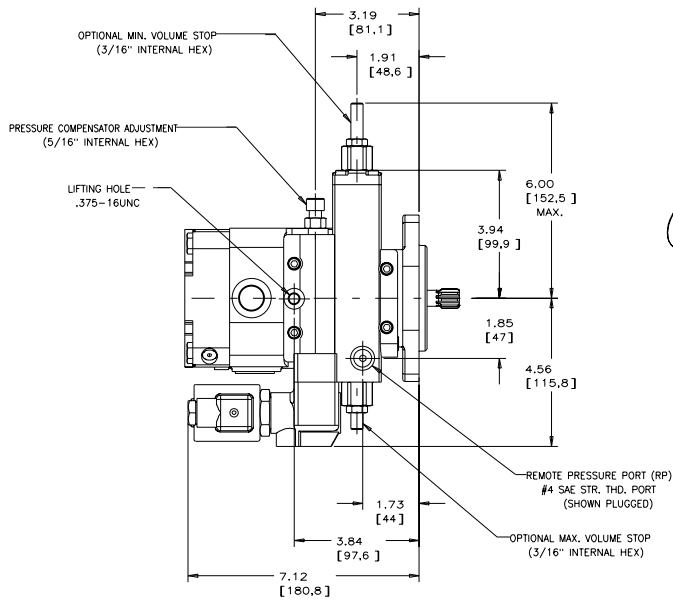

FOR BASIC PUMP DIMENSIONS SEE PLANOGRAPHS:
SIZE -011/-014/-022 PUMPS: DS-47480, DS-47481, DS-47482

520012-104

Telephone: (414) 327-1700
Fax: (414) 327-0532

OILGEAR
2300 So. 51st. Street
Milwaukee, WI USA 53219
www.oilgear.com

Issued: Aug., 2006
DS-47990