



PUMP, VARIABLE DELIVERY PVWJ 025, 034 & 046

ENGINEERING

1

P-1NN/F, P-LNN/F, P-1NNN/J, P-LNN/J P-1NN/K and P-LNN/K Controls

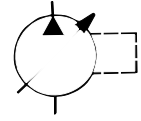

Installation Single Pressure Compensator w/Load Sense Control (B Frame)

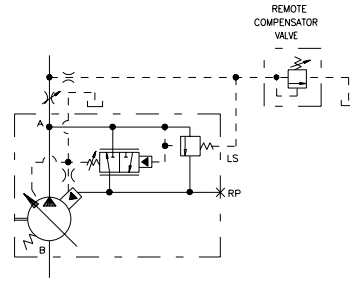
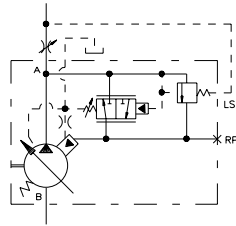

PUMP WITH REMOTE PRESSURE CONTROL

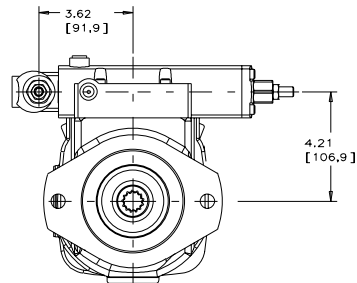
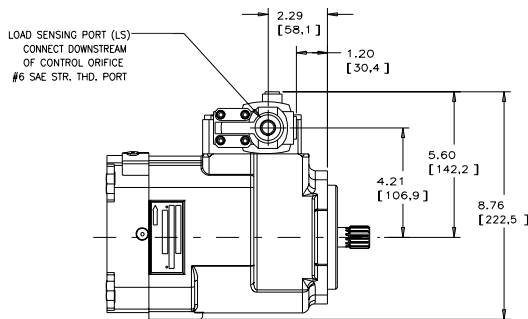
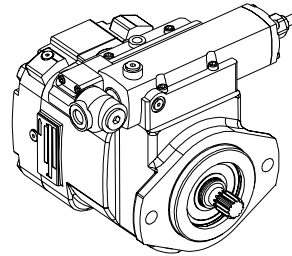
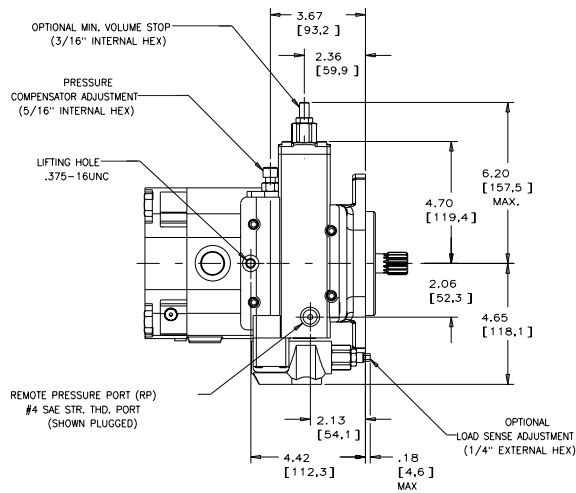

FOR BASIC PUMP DIMENSIONS SEE PLANOGRAPHS:
SIZE -025/-034/-046 PUMPS: DS-47483, DS-47484, DS-47485

520012-202

Telephone: (414) 327-1700
Fax: (414) 327-0532

OILGEAR
2300 So. 51st. Street
Milwaukee, WI USA 53219
www.oilgear.com

Issued: Aug., 2006
DS-47988



PUMP, VARIABLE DELIVERY PVWJ 025, 034 & 046

ENGINEERING

2

P-1NN/F, P-LNN/F, P-1NNN/J, P-LNN/J
P-1NN/K and P-LNN/K Controls

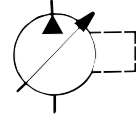

Installation Single Pressure Compensator w/Load Sense Control & Max. Volume Stop (B Frame)

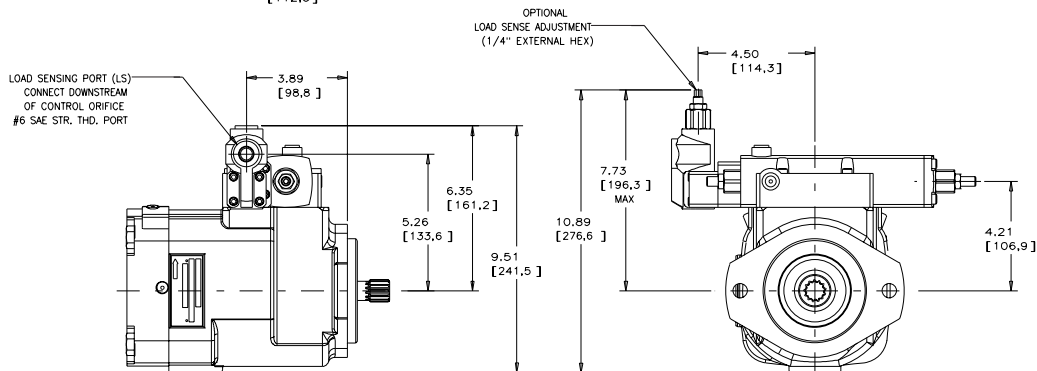
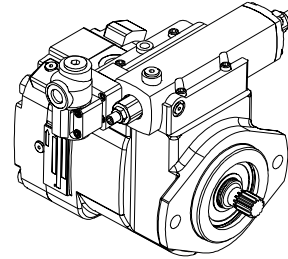
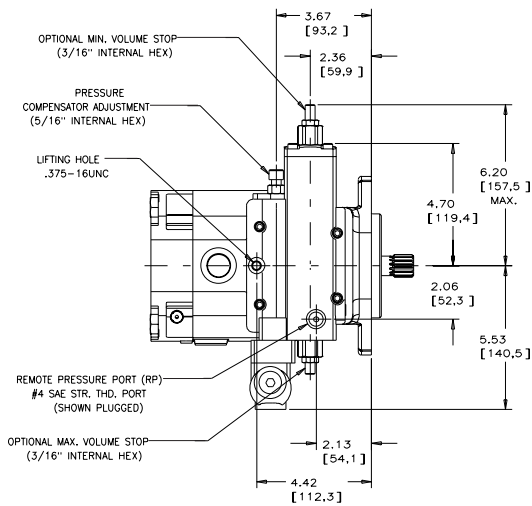
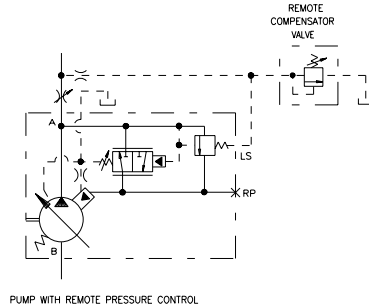
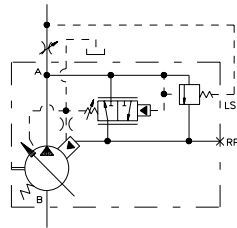

520012-203

FOR BASIC PUMP DIMENSIONS SEE PLANOGRAPHS:
SIZE -025/-034/-046 PUMPS: DS-47483, DS-47484, DS-47485

Issued: Aug., 2006
DS-47988

OILGEAR
2300 So. 51st. Street
Milwaukee, WI USA 53219
www.oilgear.com

Telephone: (414) 327-1700
Fax: (414) 327-0532